



RUT300



HARDWARE

FRONT VIEW

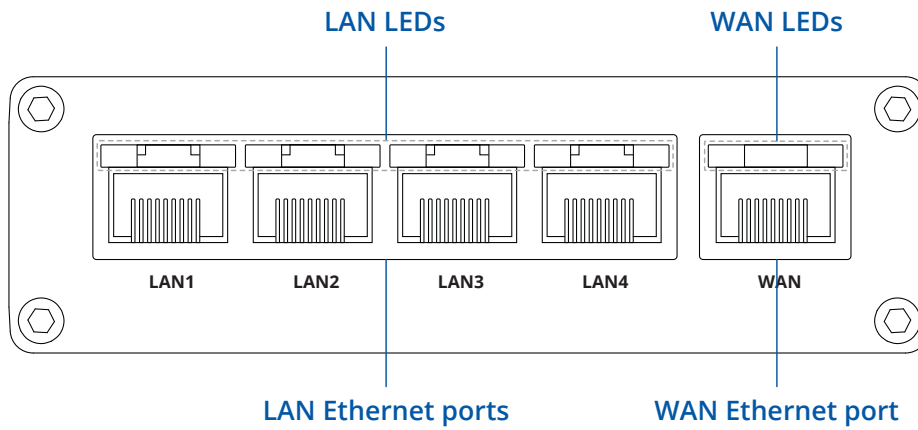

BACK VIEW

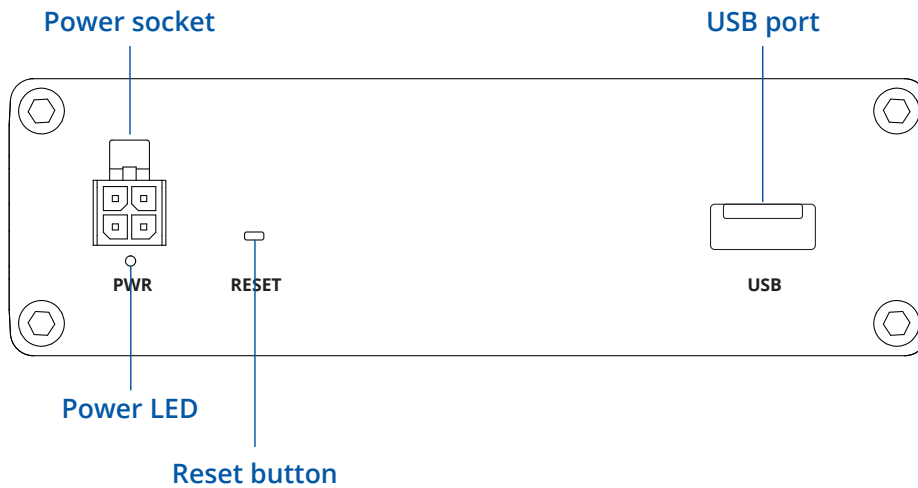

POWER SOCKET PINOUT

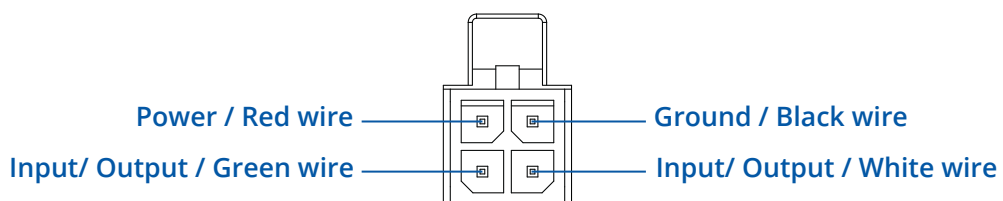

I/O (PIN 3 and 4): Configurable digital Input/Output pins. Open collector output, max output 30 V, 300 mA or Digital input where 0-6 V detected as logic low and 8-30 V - logic high

FEATURES

ETHERNET

WAN	1 x WAN port, 10/100 Mbps, compliance with IEEE 802.3, IEEE 802.3u standards, supports auto MDI/MDIX crossover
LAN	4 x LAN ports (can be configured as secondary WAN ports), 10/100 Mbps, compliance with IEEE 802.3, IEEE 802.3u standards, supports auto MDI/MDIX crossover

NETWORK

Routing	Static routes, Dynamic routes (planned)
Network protocols	TCP, UDP, IPv4, IPv6, ICMP, NTP, DNS, HTTP, HTTPS, FTP (planned), SMTP, SSL v3, TLS, ARP, PPPoE, UPNP, SSH, DHCP, Telnet client, SNMP (planned), MQTT (planned), Wake on LAN (WOL) (planned)
VoIP passthrough support	H.323 and SIP-alg protocol NAT helpers, allowing proper routing of VoIP packets
Connection monitoring	Ping Reboot, Wget reboot, Periodic Reboot, LCP and ICMP for link inspection
Firewall	Port forwards, traffic rules, NAT rules, custom rules
DHCP	Static and dynamic IP allocation, DHCP Relay
QoS / Smart Queue Management (SQM) (planned)	Traffic priority queuing by source/destination, service, protocol or port, WMM, 802.11e
DDNS (planned)	Supported >25 service providers, others can be configured manually
Network backup	Wired WAN options, each of which can be used as an automatic Failover
Load balancing	Balance Internet traffic over multiple WAN connections
SSHFS	Possibility to mount remote file system via SSH protocol

SECURITY

Authentication	Pre-shared key, digital certificates, X.509 certificates
Firewall	Pre-configured firewall rules can be enabled via WebUI, unlimited firewall configuration via CLI; DMZ; NAT; NAT-T
Attack prevention	DDOS prevention (SYN flood protection, SSH attack prevention, HTTP/HTTPS attack prevention), port scan prevention (SYN-FIN, SYN-RST, X-mas, NULL flags, FIN scan attacks)
VLAN	Port and tag based VLAN separation
WEB filter (planned)	Blacklist for blocking out unwanted websites, Whitelist for specifying allowed sites only
Access control	Flexible access control of TCP, UDP, ICMP packets, MAC address filter

VPN

OpenVPN	Multiple clients and a server can run simultaneously, 12 encryption methods
OpenVPN Encryption	DES-CBC, RC2-CBC, DES-EDE-CBC, DES-EDE3-CBC, DESX-CBC, BF-CBC, RC2-40-CBC, CAST5-CBC, RC2-64-CBC, AES-128-CBC, AES-192-CBC, AES-256-CBC
IPSec	IKEv1, IKEv2, with 5 encryption methods for IPsec (DES, 3DES, AES128, AES192, AES256)
GRE	GRE tunnel
PPTP, L2TP	Client/Server instances can run simultaneously, L2TPv3 support (planned)
Stunnel (planned)	Proxy designed to add TLS encryption functionality to existing clients and servers without any changes in the program's code
DMVPN (planned)	Method of building scalable IPsec VPNs
SSTP (planned)	SSTP client instance support
ZeroTier	ZeroTier VPN client support
WireGuard	WireGuard VPN client and server support

MODBUS TCP SLAVE (PLANNED)

ID filtering	Respond to one ID in range [1;255] or any
Allow remote access	Allow access through WAN
Custom registers	MODBUS TCP custom register block, which allows to read/write to a file inside the router, and can be used to extend MODBUS TCP slave functionality

MODBUS TCP MASTER (PLANNED)

Supported functions	01, 02, 03, 04, 05, 06, 15, 16
Supported data formats	8 bit: INT, UINT; 16 bit: INT, UINT (MSB or LSB first); 32 bit: float, INT, UINT (ABCD (big-endian), DCBA (little-endian), CDAB, BADC), HEX, ASCII

MQTT GATEWAY (PLANNED)

Gateway	Allows sending commands and receiving data from MODBUS Master through MQTT broker
---------	---

DATA TO SERVER (PLANNED)

Protocols	HTTP(S), MQTT, Azure MQTT, Kinesis
-----------	------------------------------------

MONITORING & MANAGEMENT

WEB UI	HTTP/HTTPS, status, configuration, FW update, CLI, troubleshoot, event log, system log, kernel log
FOTA	Firmware update from server, automatic notification
SSH	SSH (v1, v2)
TR-069	OpenACS, EasyCwmp, ACSLite, tGem, LibreACS, GenieACS, FreeACS, LibCWMP, Friendly tech, AVSystem
MQTT (planned)	MQTT Broker, MQTT publisher
SNMP (planned)	SNMP (v1, v2, v3), SNMP trap
JSON-RPC	Management API over HTTP/HTTPS
MODBUS (planned)	MODBUS TCP status/control
RMS	Teltonika Remote Management System (RMS)

SYSTEM CHARACTERISTICS

CPU	QCA9531, MIPS 24kc, 650 MHz
RAM	64 MB, DDR2
FLASH storage	16 MB, SPI Flash

FIRMWARE / CONFIGURATION

WEB UI	Update FW from file, check FW on server, configuration profiles, configuration backup
FOTA	Update FW/configuration from server
RMS	Update FW/configuration for multiple devices at once
Keep settings	Update FW without losing current configuration

USB

Data rate	USB 2.0
Applications	Samba share (planned), USB-to-serial (planned)
External devices	Possibility to connect external HDD, flash drive, printer (planned)
Storage formats	FAT, FAT32, NTFS

INPUT/OUTPUT

Configurable I/O	2 x Configurable digital Inputs/Outputs. Digital input 0 - 6 V detected as logic low, 8 - 30 V detected as logic high. Open collector output, max output 30 V, 300 mA
Events	Email, RMS
I/O juggler	Allows to set certain I/O conditions to initiate event

POWER

Connector	4 pin industrial DC power socket
Input voltage range	7 - 30 VDC, reverse polarity protection, voltage surge/transient protection
PoE (passive)	Passive PoE. Possibility to power up through LAN port, not compatible with IEEE802.3af, 802.3at and 802.3bt standards
Power consumption	Idle: 1.3 W, Max: 3 W

PHYSICAL INTERFACES (PORTS, LEADS, ANTENNAS, BUTTONS, SIM)

Ethernet	5 x RJ45 ports, 10/100 Mbps
I/Os	2 x Configurable digital Inputs/Outputs on 4 pin power connector
Status LEDs	5 x ETH status, 1 x Power
Power	1 x 4 pin DC connector
USB	1 x USB A port for external devices
Reset	Reboot/User default reset/Factory reset button

PHYSICAL SPECIFICATION

Casing material	Aluminium housing with DIN rail mounting option
Dimensions (W x H x D)	100 x 30 x 85 mm
Weight	229 g
Mounting options	DIN rail, flat surface placement

OPERATING ENVIRONMENT

Operating temperature	-40 C to 75 C
Operating humidity	10 % to 90 % non-condensing

HARDWARE INSTALLATION

1. Connect the power adapter to the socket on the back of the device. Then plug the other end of the power adapter into a power outlet.
2. Connect to the device via an Ethernet cable connected to LAN port.

LOGIN TO DEVICE

1. To enter the router's Web interface (WebUI), type <http://192.168.1.1> into the URL field of your Internet browser.
2. Use login information shown in image A when prompted for authentication.
3. After you login, you will be prompted to change your password for security reasons. The new password must contain at least 8 characters, including at least one uppercase letter, one lowercase letter and one digit. This step is mandatory and **you will not be able to interact with the router's WebUI before you change the password.**
4. When you change the router's password, the [Configuration Wizard](#) will start. The [Configuration Wizard](#) is a tool used to setup some of the router's main operating parameters.

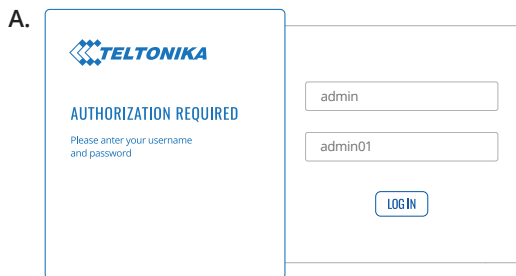

TECHNICAL INFORMATION

Bundled accessories specifications*	
Power adapter	Input: 0.4A@100-240VAC, Output: 9VDC, 1A, 4-pin plug

*Order code dependent.

WHAT'S IN THE BOX?

STANDARD PACKAGE CONTAINS*

- Router RUT300
- 9 W PSU
- Ethernet cable (1.5 m)
- QSG (Quick Start Guide)
- RMS Flyer
- Packaging box



ROUTER RUT300



9 W PSU



ETHERNET CABLE (1.5 M)

* For all standard order codes standard package contents are the same, except for PSU.

STANDARD ORDER CODES

PRODUCT CODE	HS CODE	HTS CODE	PACKAGE CONTAINS
RUT300 000000	851762	8517.62.00	Standard package with Euro PSU
RUT300 000100	851762	8517.62.00	Standard package with US PSU

For more information on all available packaging options – please contact us directly.

MOUNTING OPTIONS

DIN RAIL KIT

Parameter	Value
Mounting standard	35mm DIN Rail
Material	Low carbon steel
Weight	57g
Screws included	Philips Pan Head screw #6-32×3/16, 2pcs
Dimensions	82 mm x 46 mm x 20 mm
RoHS Compliant	V

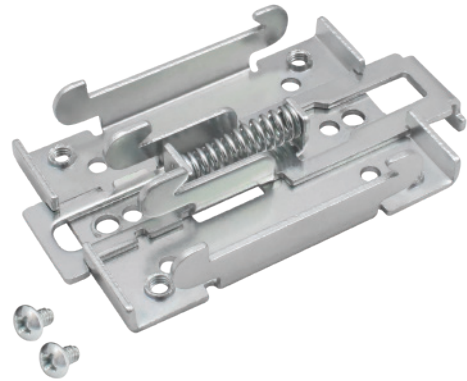

DIN RAIL KIT

- DIN Rail adapter
- Philips Pan Head screw #6-32×3/16, 2pcs for RUT2xx/RUT9xx

ORDER CODE

PR5MEC00

HS CODE

73269098

HTS CODE

7326.90.98

For more information on all available packaging options – please contact us directly.

COMPACT DIN RAIL KIT

Parameter	Value
Mounting standard	35mm DIN Rail
Material	ABS + PC plastic
Weight	6.5 g
Screws included	Philips Pan Head screw #6-32×3/16, 2pcs
Dimensions	70 mm x 25 mm x 14,5 mm
RoHS Compliant	V



DIN RAIL KIT

- Compact plastic DIN Rail adapter (70x25x14,5mm)
- Philips Pan Head screw #6-32×3/16, 2pcs

ORDER CODE

PR5MEC11

HS CODE

73269098

HTS CODE

7326.90.98

For more information on all available packaging options – please contact us directly.

SURFACE MOUNTING KIT

Parameter	Value
Mounting standard	Flat surface mount
Material	ABS + PC plastic
Weight	2x5 g
Screws included	Philips Pan Head screw #6-32×3/16, 2pcs
Dimensions	25 mm x 48 mm x 7.5 mm
RoHS Compliant	V



DIN RAIL KIT

- Surface mounting kit
- Philips Pan Head screw #6-32×3/16, 2pcs

ORDER CODE

PR5MEC12

HS CODE

73269098

HTS CODE

7326.90.98

For more information on all available packaging options – please contact us directly.

RUT300 SPATIAL MEASUREMENTS & WEIGHT

MAIN MEASUREMENTS

W x H x D dimensions for RUT300:

Device housing*: 100 x 30 x 85

Box: 173 x 71 x 148

*Housing measurements are presented without antenna connectors and screws; for measurements of other device elements look to the sections below.

TOP VIEW

The figure below depicts the measurements of RUT300 and its components as seen from the top:

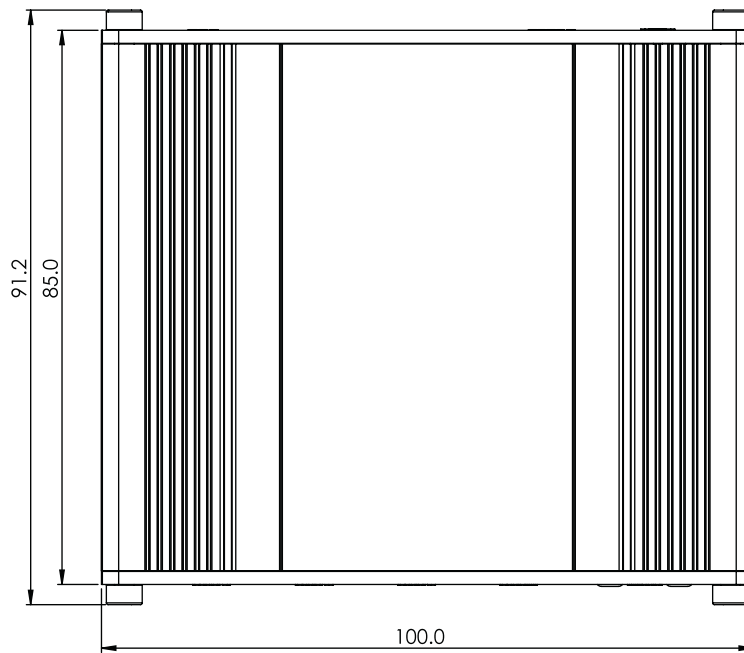

RIGHT VIEW

The figure below depicts the measurements of RUT300 and its components as seen from the right side:

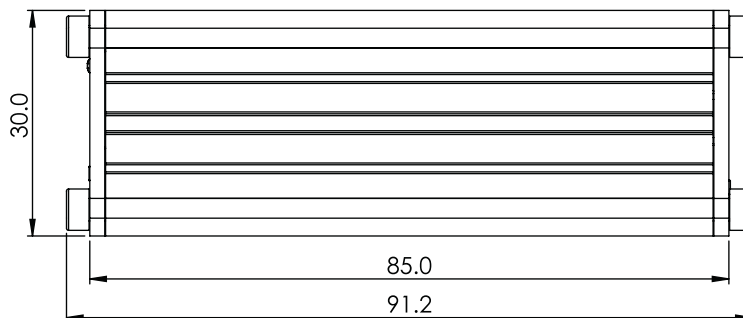

FRONT VIEW

The figure below depicts the measurements of RUT300 and its components as seen from the front panel side:

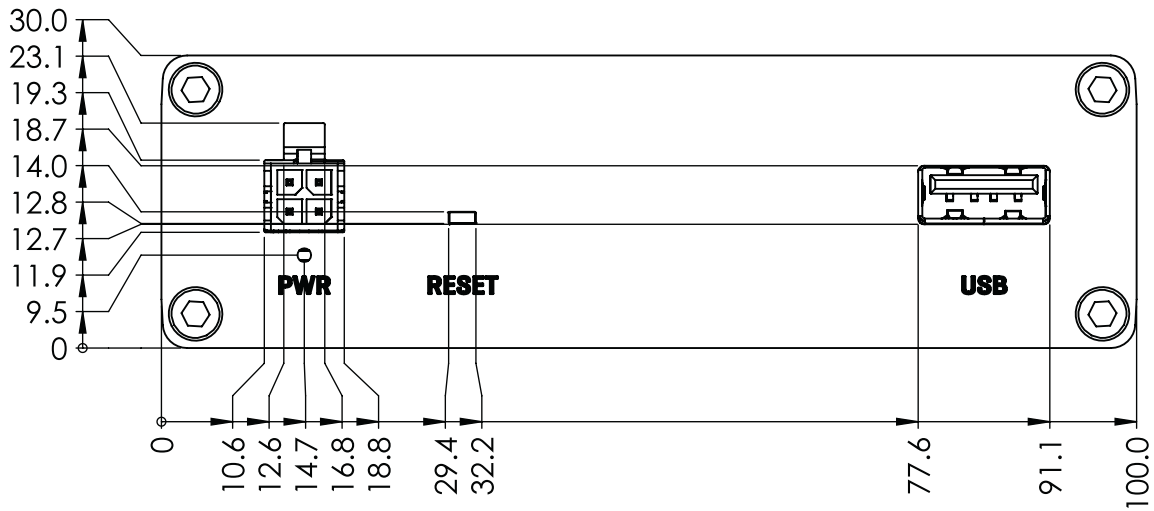

REAR VIEW

The figure below depicts the measurements of RUT300 and its components as seen from the back panel side:

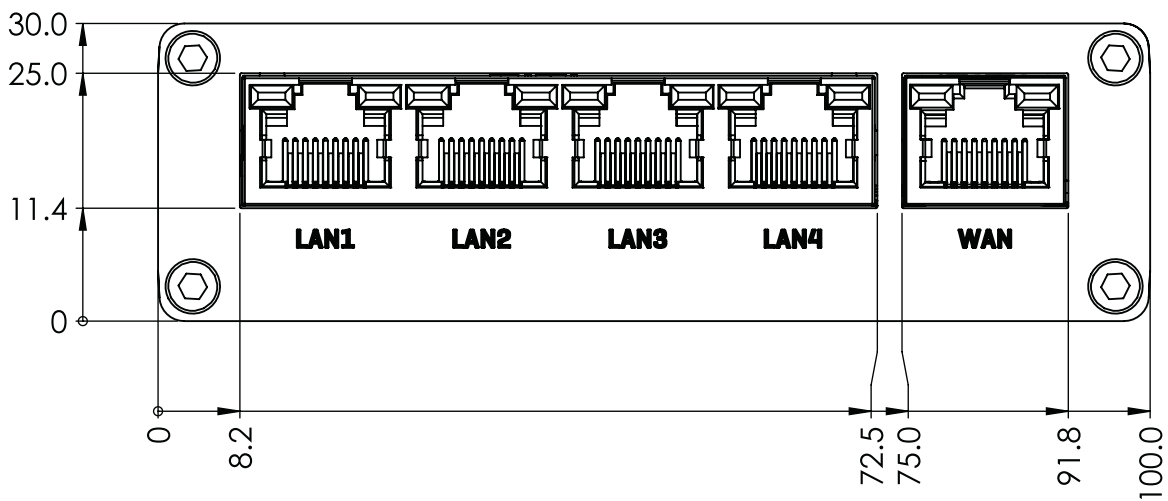

MOUNTING SPACE REQUIREMENTS

The figure below depicts an approximation of the device's dimensions when cables and antennas are attached:

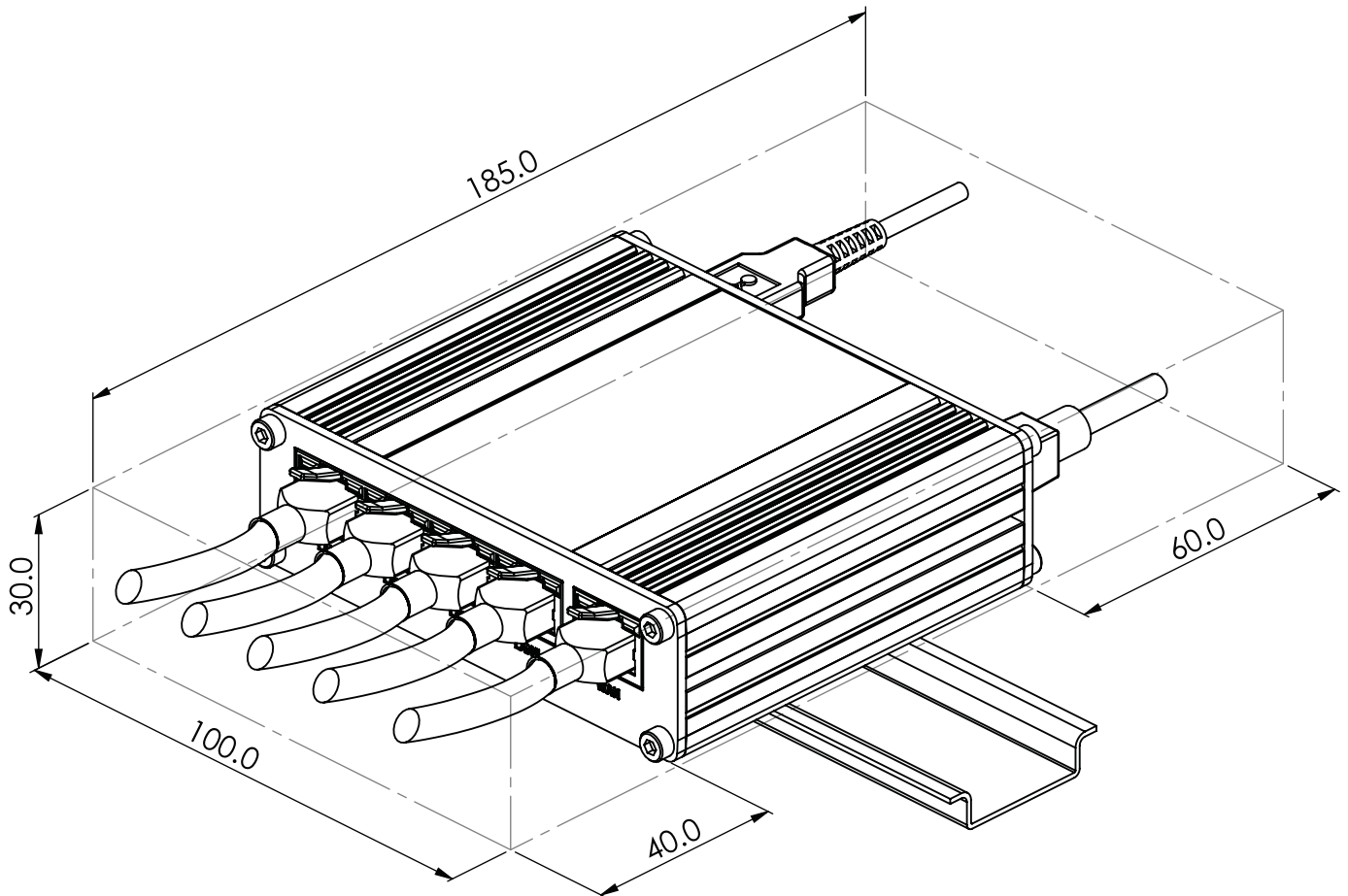

DIN RAIL

The scheme below depicts protrusion measurements of an attached DIN Rail:

