



## Package Contents



U-LTE



Stand



Mounting Bracket



Double-Sided Adhesive



Self-Tapping Screws (Qty. 2)



Screw Anchors (Qty. 2)



RP-SMA Cap

## System Requirements

- Linux, Mac OS X, or Microsoft Windows 7/8/10
- Java Runtime Environment 1.8 or above recommended
- Web Browser: Google Chrome (Other browsers may have limited functionality)
- UniFi Controller software v5.12.x (or newer), available at: [ui.com/download/unifi](http://ui.com/download/unifi)

## Hardware Overview

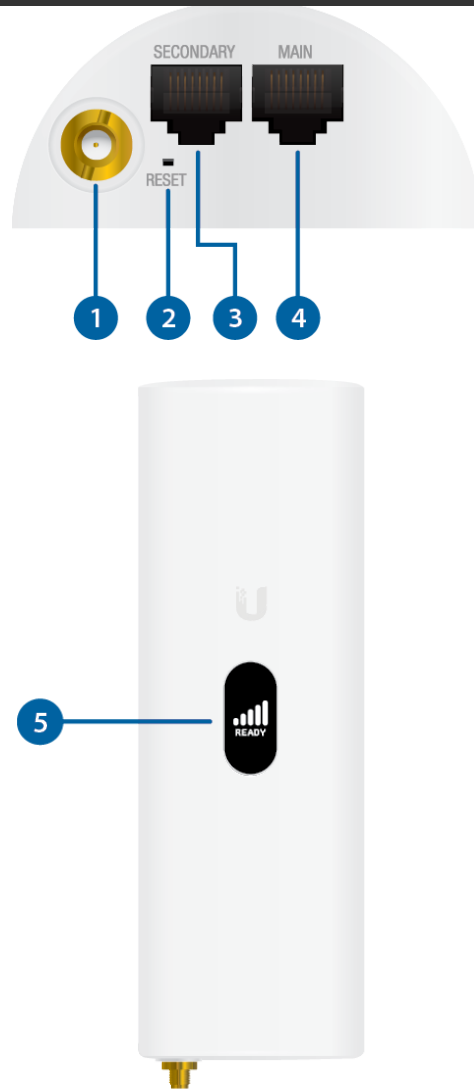

## 1 RP-SMA Antenna Connector

You can connect an optional external LTE antenna (not included). If you are not using an external antenna, then you can cover the connector with the RP-SMA Cap.

## 2 Reset Button

The Reset Button serves two functions:

- Restart Press and release the Reset button quickly.
- Restore to Factory Default Settings Press and hold the Reset button for more than five seconds, until the display indicates “Factory Reset”.

## 3 Secondary

This Gigabit Ethernet port is used for bridging and can provide passive PoE to a device.

## 4 Main



802.3at PoE+ switch, such as a UniFi PoE Switch.

### 5 LCD Screen

Displays status information, including the LTE signal strength.

## Installation Requirements

- Phillips screwdriver
- Wall-mounting (optional): drill with 6 mm drill bit
- For WAN failover:
  - UniFi Dream Machine, model UDM
  - UniFi Security Gateway, model USG, USG-PRO-4, or USG-XG-8
- UniFi cloud account



**Note:** The U-LTE can only be adopted via remote access at: [unifi.ui.com](https://unifi.ui.com)

- Activation of Ubiquiti LTE data plan
- For indoor applications, use Category 5 (or above) UTP cabling approved for indoor use.
- For outdoor applications, shielded Category 5 (or above) cabling should be used for all wired Ethernet connections and should be grounded through the AC ground of the power supply.

We recommend that you protect your networks from harmful outdoor environments and destructive ESD events with industrial-grade, shielded Ethernet cable from Ubiquiti. For more details, visit: [ui.com/toughcable](https://ui.com/toughcable)



**WARNING:** To reduce the risk of fire or electric shock, do not expose this product to rain or moisture.



**Note:** Although the cabling can be located outdoors, the U-LTE itself should be housed inside a protective enclosure.

## Hardware Installation

The U-LTE can be mounted in three ways:

- Screw Mount
- [“Adhesive Mount”](#)
- [“Desktop Mount”](#)

### Screw Mount

1.

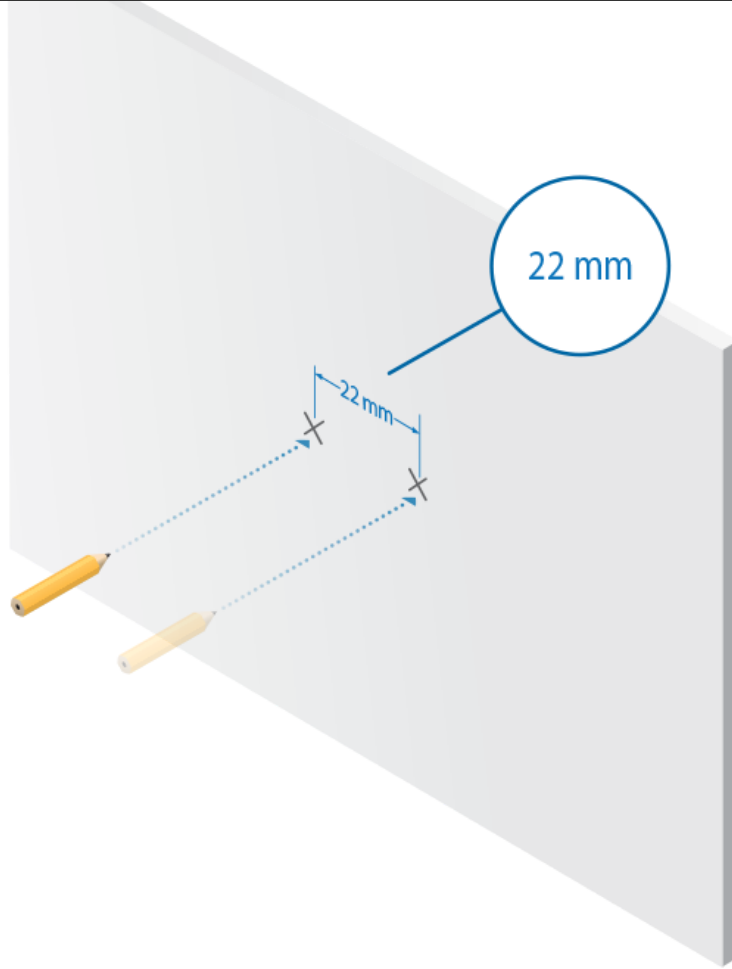

2.

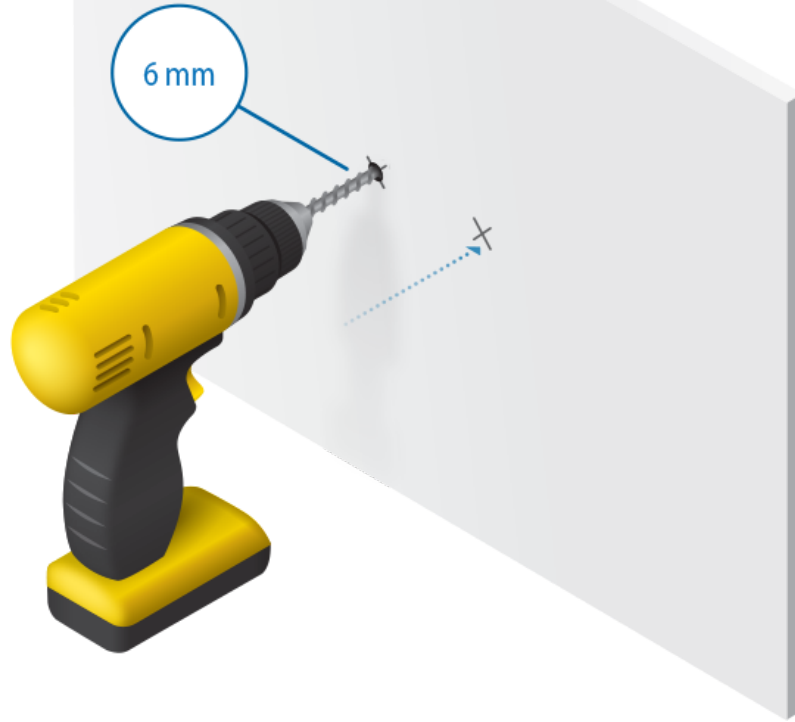

3.

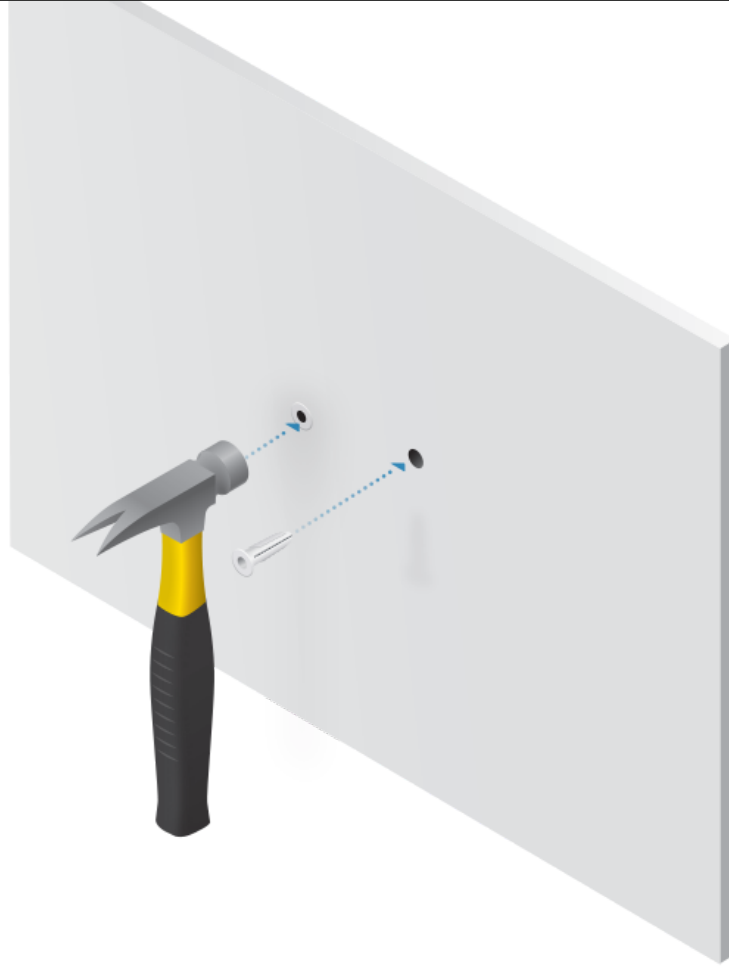

4.

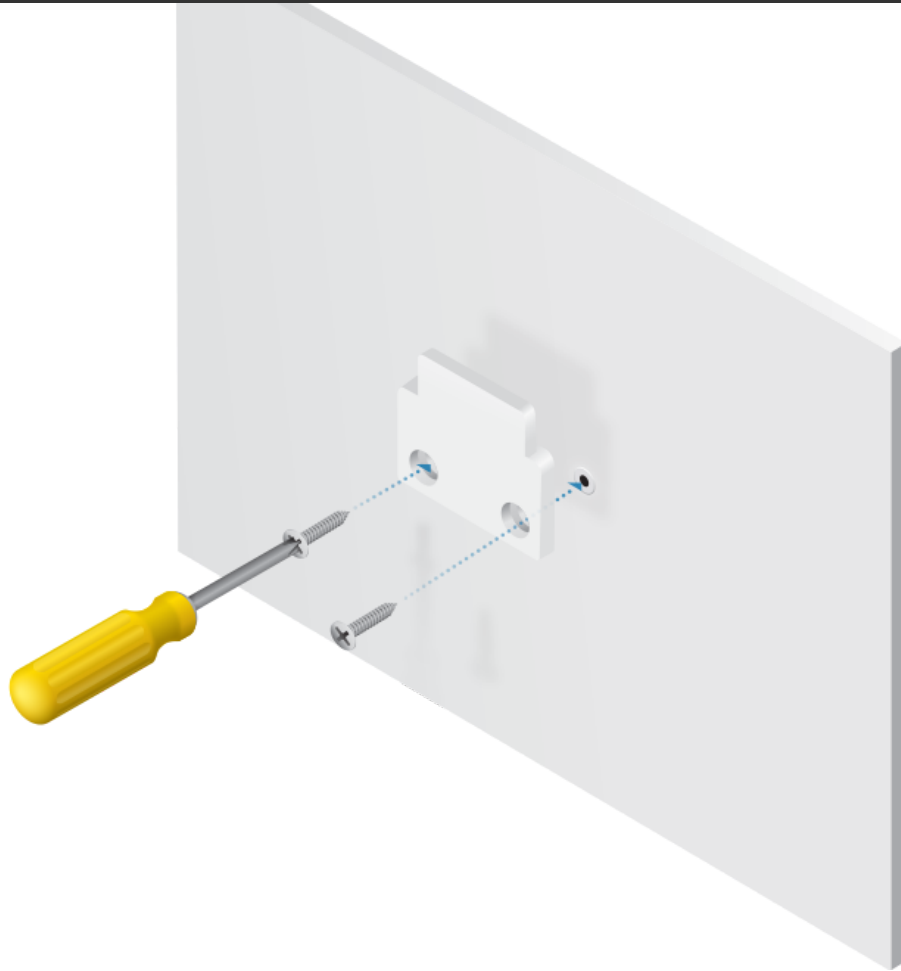

5.

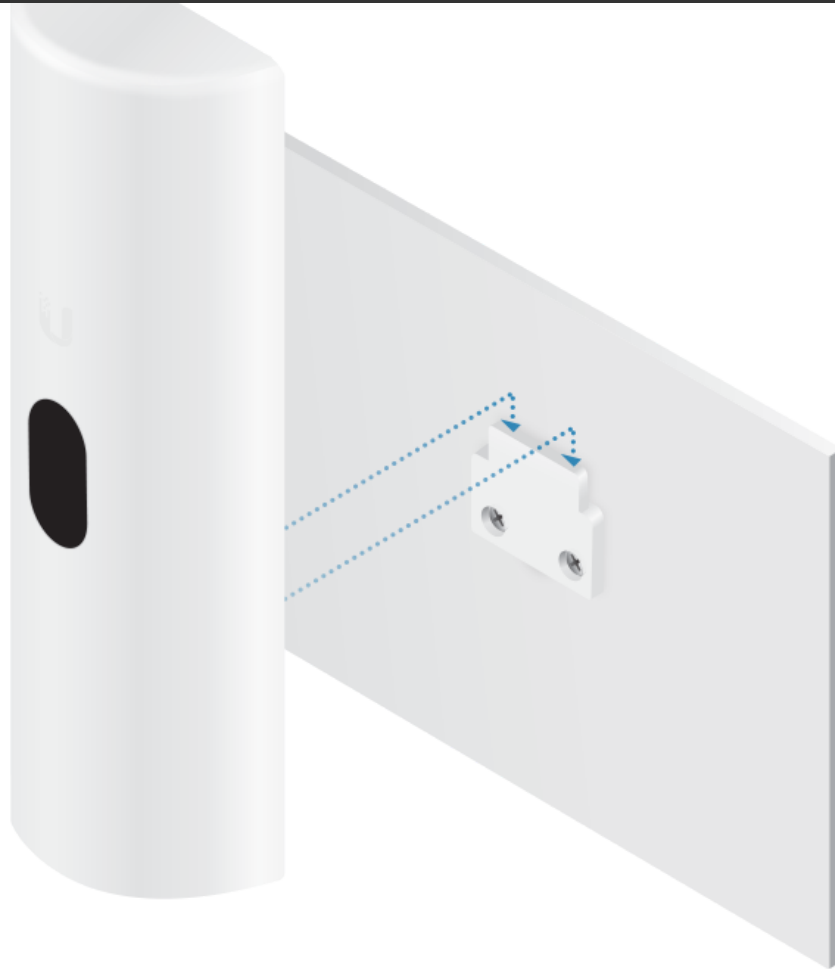

Proceed to [“Connecting Ethernet”](#).

## Adhesive Mount

1.

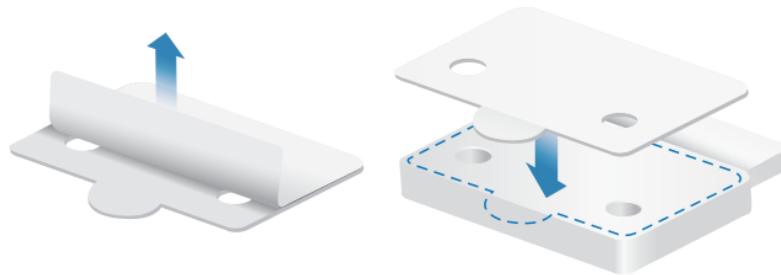

2.



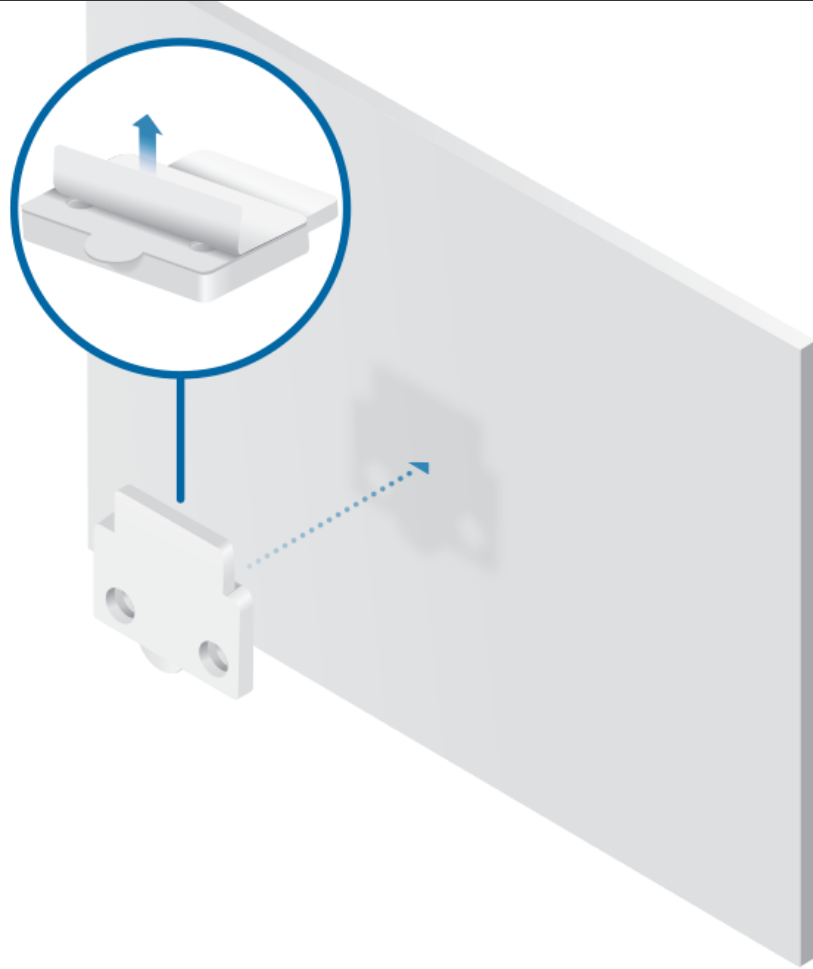

3.

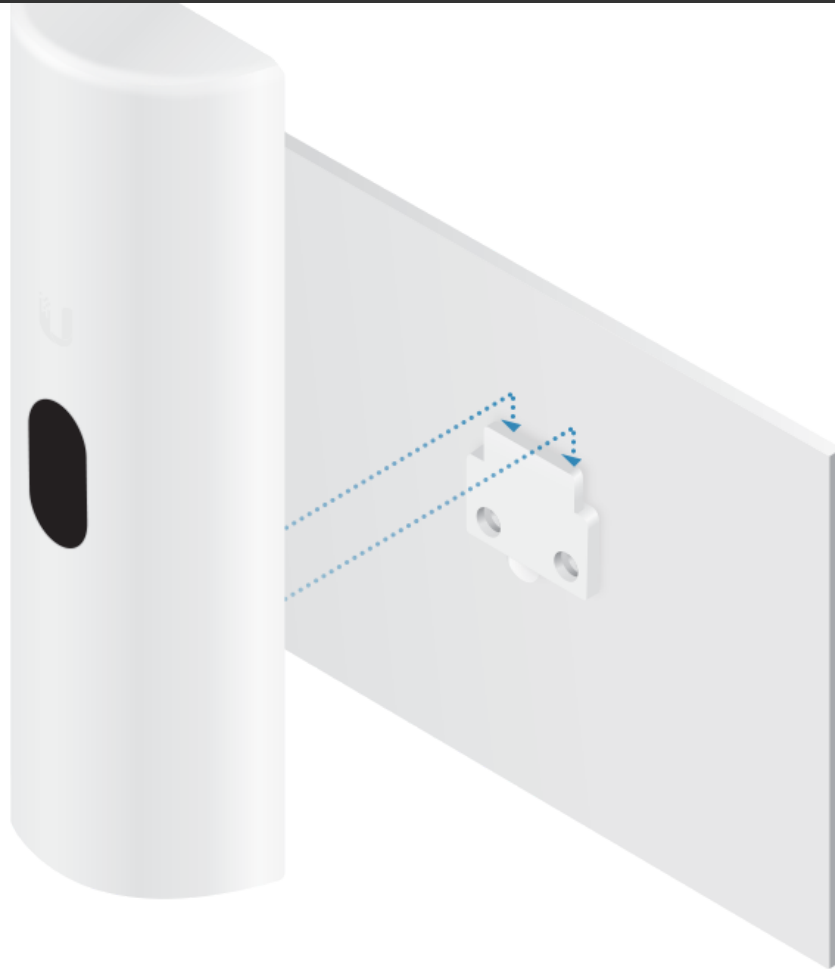

Proceed to [“Connecting Ethernet”](#).

## Desktop Mount

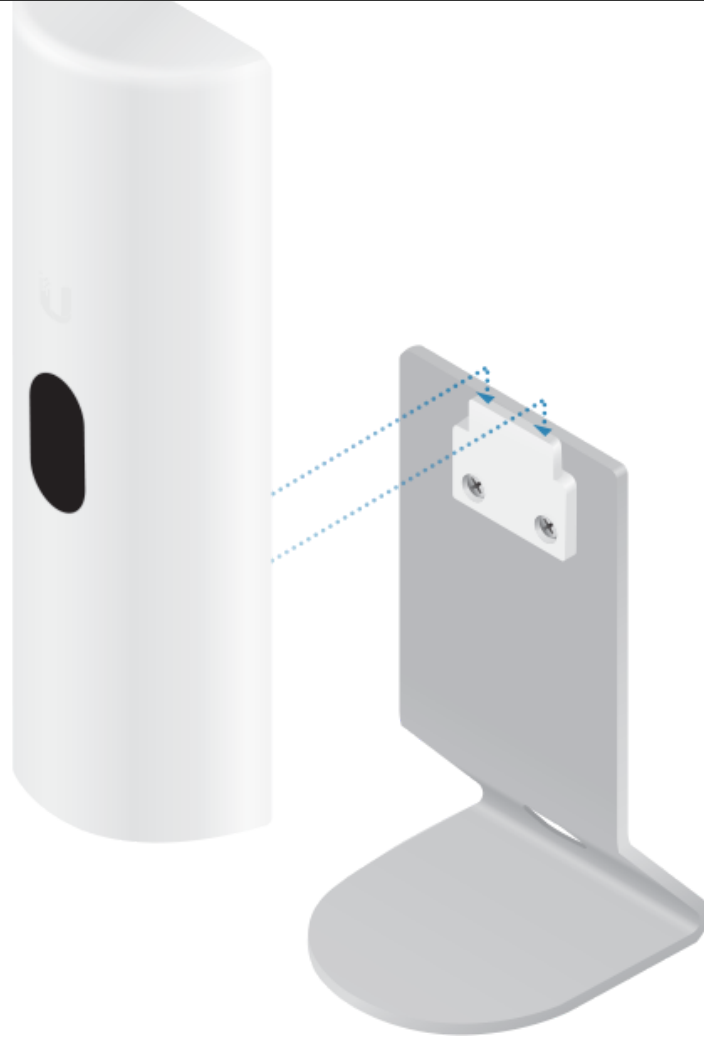

## Connecting Ethernet

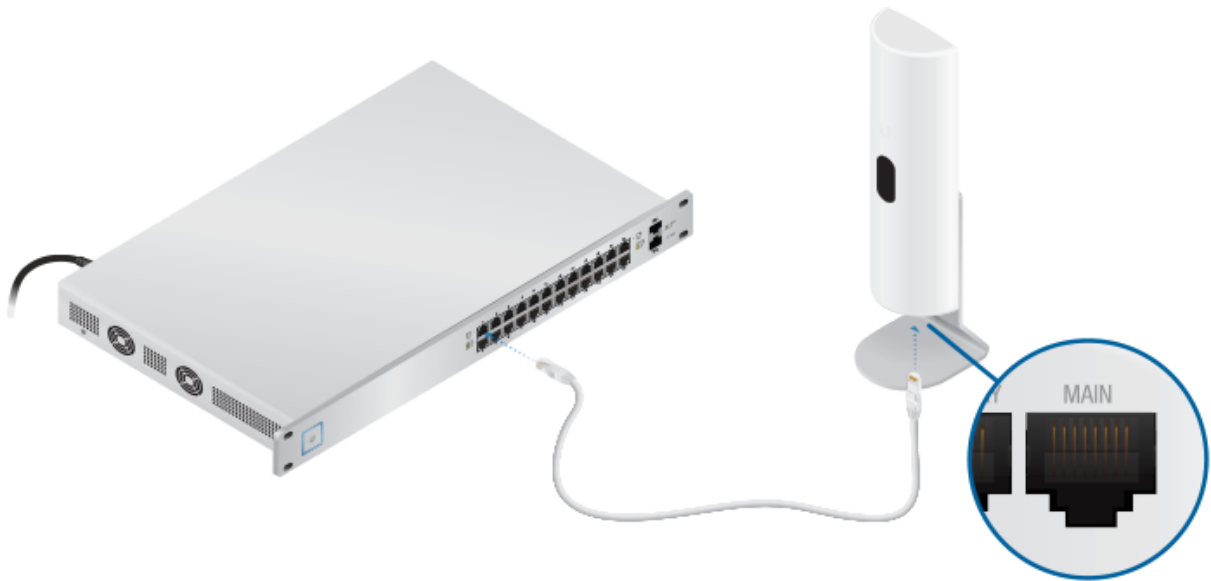

Setup

Overview



## U-LTE Quick Start Guide

- Adopt the U-LTE in the UniFi Controller Software.
- Set up your LTE account. You can manage your LTE subscription at: [account.ui.com/subscriptions](https://account.ui.com/subscriptions)

If the primary WAN 1 or 2 goes offline, then the configured networks fail over to the U-LTE.

## Configuration

1. In the UniFi Controller, click the Devices  tab. The U-LTE should be automatically detected and begin the setup wizard; proceed to step 2. Otherwise, select the U-LTE and click Adopt.

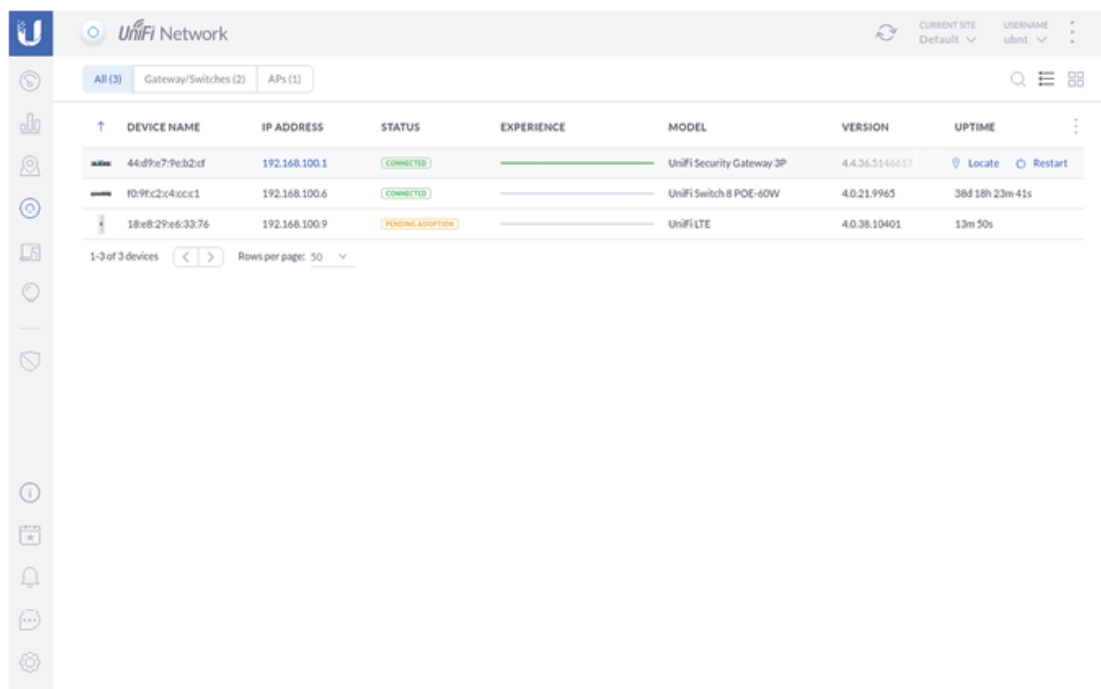

2. Click Setup LTE.

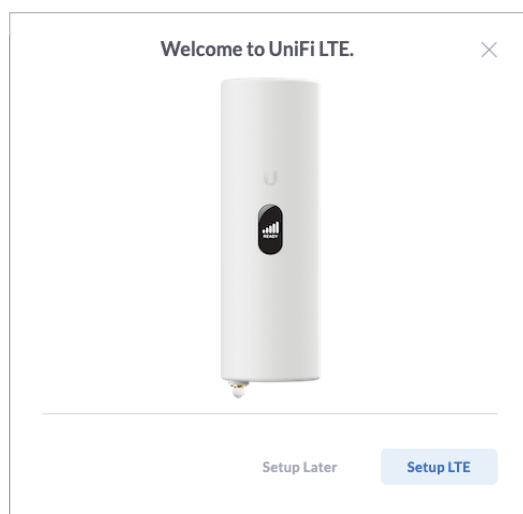

3. For your ui.com account, enter your email address or username and password. Select I agree to the Terms of Service and click Next.

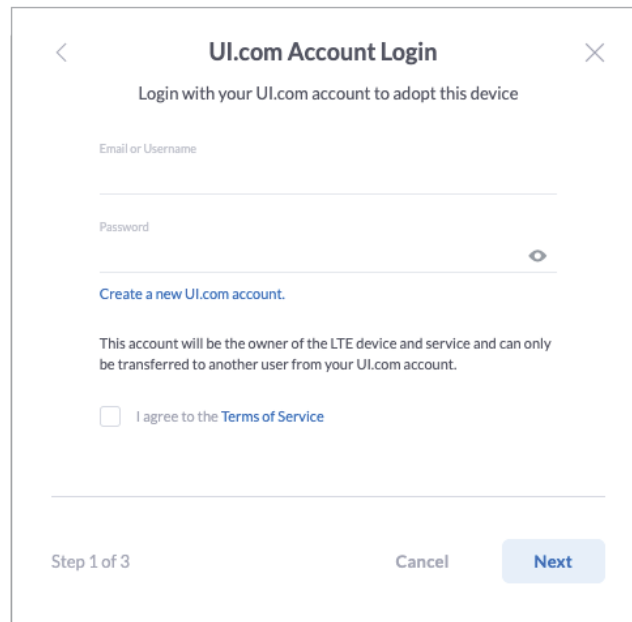

The screenshot shows the 'UI.com Account Login' screen. At the top, there is a back arrow on the left and a close 'X' icon on the right. The title is 'UI.com Account Login' and the subtitle is 'Login with your UI.com account to adopt this device'. Below this, there are two input fields: 'Email or Username' and 'Password'. The password field has an eye icon to toggle visibility. A link 'Create a new UI.com account.' is located below the password field. A paragraph of text states: 'This account will be the owner of the LTE device and service and can only be transferred to another user from your UI.com account.' Below this is a checkbox with the text 'I agree to the Terms of Service'. At the bottom, there is a progress indicator 'Step 1 of 3', a 'Cancel' button, and a 'Next' button.

4. For payment information, enter the following:

- Credit card number
- Expiration month and year in this format: MM/YY
- CVC (Card Verification Code) on the back of your card

Click Next.

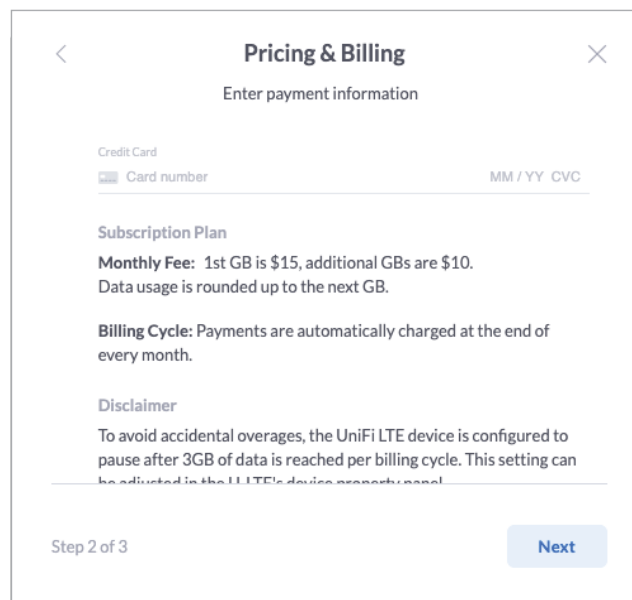

The screenshot shows the 'Pricing & Billing' screen. At the top, there is a back arrow on the left and a close 'X' icon on the right. The title is 'Pricing & Billing' and the subtitle is 'Enter payment information'. Below this, there is a 'Credit Card' section with a card icon and two input fields: 'Card number' and 'MM / YY CVC'. A 'Subscription Plan' section follows, with 'Monthly Fee: 1st GB is \$15, additional GBs are \$10. Data usage is rounded up to the next GB.' and 'Billing Cycle: Payments are automatically charged at the end of every month.' A 'Disclaimer' section at the bottom states: 'To avoid accidental overages, the UniFi LTE device is configured to pause after 3GB of data is reached per billing cycle. This setting can be adjusted in the LTE's device properties panel.' At the bottom, there is a progress indicator 'Step 2 of 3' and a 'Next' button.

5. The U-LTE will reboot. It can take up to 20 minutes to activate on the cellular network. Click Done to close this screen.



# U-LTE Quick Start Guide

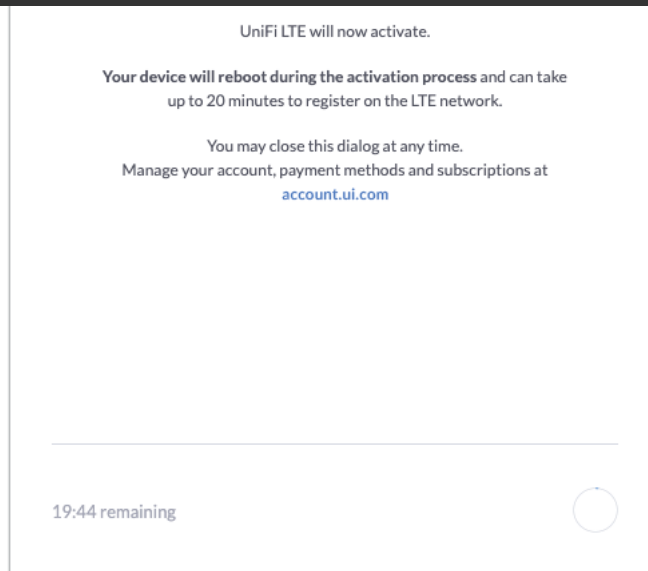

## Using the U-LTE

To monitor data usage, click the U-LTE on the Devices screen. Its Properties panel will appear.

The screenshot shows the UniFi Network management interface. The main table lists devices with columns for Device Name, IP Address, Status, Experience, and Model. The selected device is a UniFi LTE with MAC address 18:e8:29:e6:33:76 and IP address 192.168.100.9. The right-hand panel displays the 'Data Usage' section, showing 1.67 / 2 GB used. A warning message indicates that the user has exceeded 1 GB of available LTE data, and overage charges apply. Below this, an 'OVERVIEW' section provides details such as MAC Address, Model, Version, Board Revision, IP Address, Uptime, Memory Usage, and Load Average.

DEVICE NAME	IP ADDRESS	STATUS	EXPERIENCE	MODEL
44:d9:e7:9e:b2:cf	192.168.100.1	CONNECTED		UniFi Security Gate
fd:9f:c2:c4:ccc:1	192.168.100.6	CONNECTED		UniFi Switch 8 POE
18:e8:29:e6:33:76	192.168.100.9	CONNECTED		UniFi LTE
74:83:c2:14:d2:db	192.168.100.24	PENDING ADOPTION		UniFi AP-eanoHD

1-4 of 4 devices | Rows per page: 50

**Data Usage** 1.67 / 2 GB

⚠ You've exceeded 1 GB of available LTE data. Overage charges apply. When you've reached 3 GB, your LTE service will be interrupted.

Increase your total monthly LTE data limit to avoid service interruption. [Increase data limit](#)

**OVERVIEW**

- MAC Address: 18:e8:29:e6:33:76
- Model: UniFi LTE
- Version: 4.0.38.10401
- Board Revision: 21
- IP Address: 192.168.100.9
- Uptime: 1m 24s
- Memory Usage: 45%
- Load Average: 1.63 / 0.60 / 0.22

**UNIFI LTE** +

**UPLINK (WIRED)** +



## U-LTE Quick Start Guide

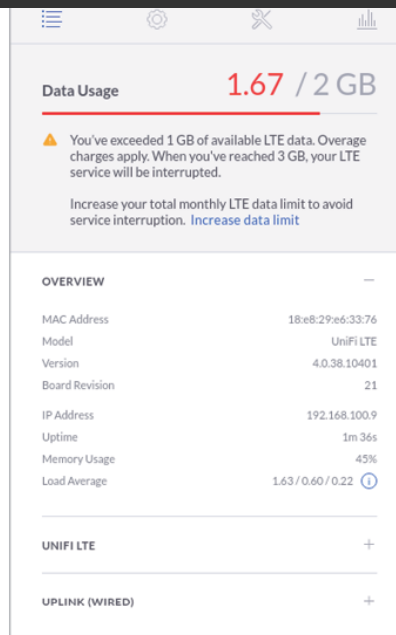

Click the Settings  icon to access the following:

- [Enable External Antenna](#) If you attach an external antenna to the U-LTE, click this option.
- [Enable PoE Passthrough](#) If you have connected a secondary PoE device to the U-LTE, click this option.
- [LTE Data Plan](#) An alert is initiated when 1 GB of data is used (by default). To change the data limit, click the Data Limit drop-down and select a different amount of data.

Click Apply to save changes.

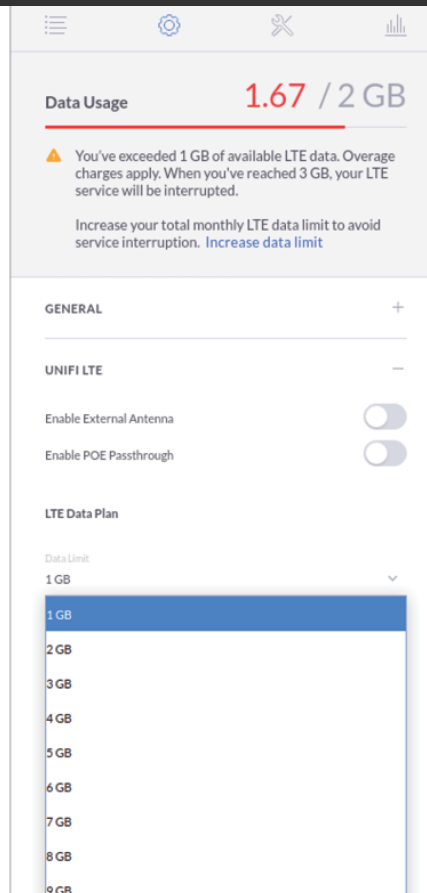

When LTE failover is active, an alert will appear in the Properties panel and the Controller's list of alerts.



**Note:** LTE failover is active by default.





# U-LTE Quick Start Guide

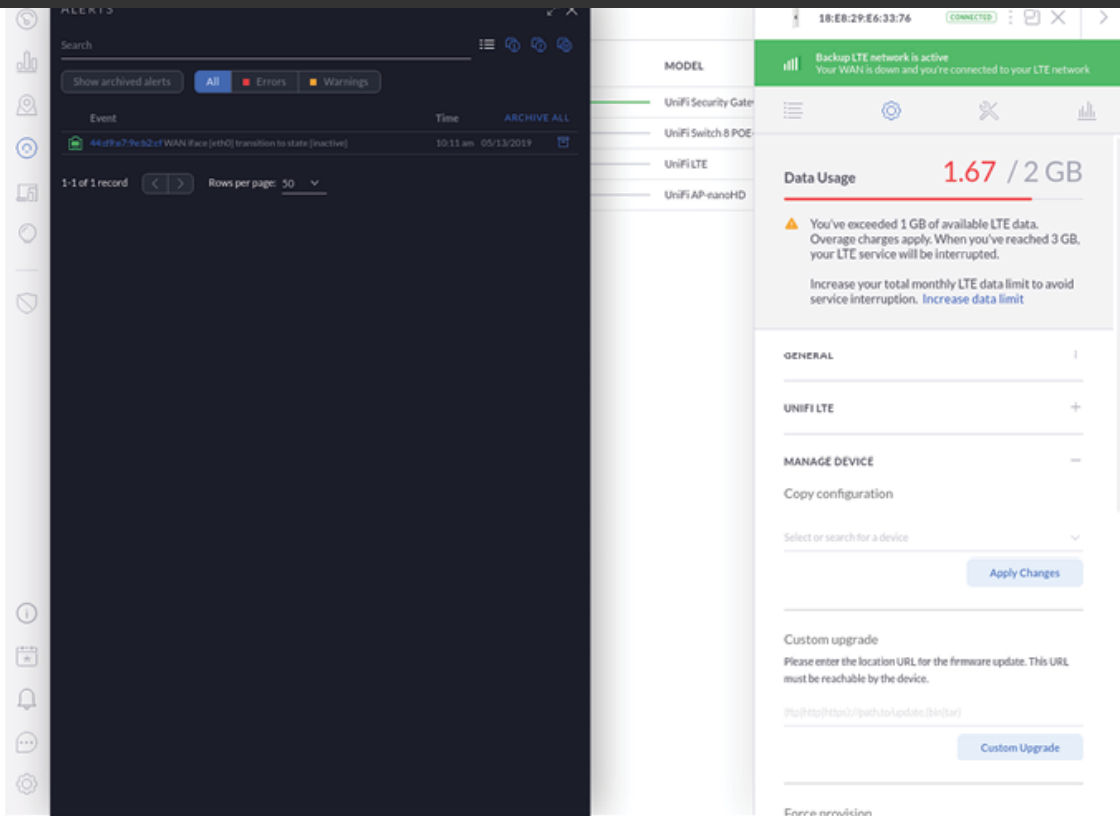

An alert will appear when LTE failover is activated or deactivated.

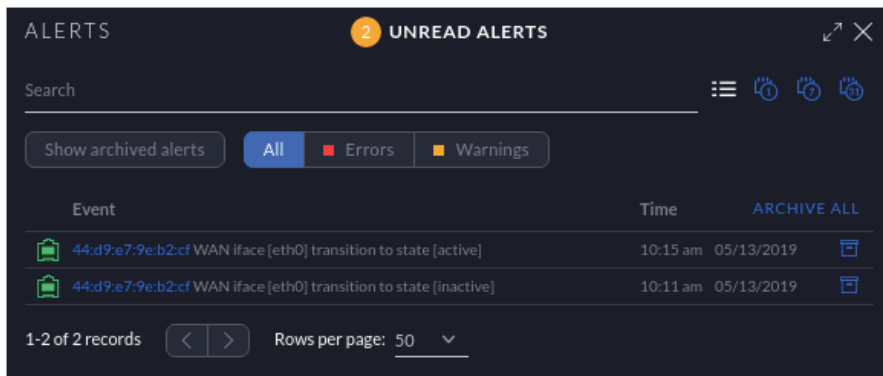

## Specifications

U-LTE	
Dimensions	66 x 202.12 x 32.2 mm (2.60 x 7.96 x 1.27")
Weight	
Without Mounting	200 g (7.06 oz)
With Mounting	316 g (11.15 oz)
Interfaces	
Networking	(2) 10/100/1000 RJ45 Ports WP7603 LTE
Management	Ethernet, Bluetooth



## U-LTE Quick Start Guide

Max. Power Consumption with PoE Passthrough	8.5W 16W*
PoE Out	48V Passthrough (Pins 1, 2+; 3, 6-)
Power Method	802.3at (Pairs 1, 2+; 3, 6-; Pairs 4, 5+; 7, 8-)
Power Supply	UniFi PoE Switch
Supported Voltage Range	44 to 57VDC
LCM	1.54" Display
LTE Category	Cat 4
LTE Bands	B2/4/5/12
Antenna LTE	(1) 2x2
2.4 GHz	(1) 1x1
2.4 GHz Antenna Gain	1.5 dBi
BT Operating Frequency	2400 - 2483.5 MHz
Mounting	Wall-Mount
Operating Temperature	-10 to 50° C (14 to 122° F)
Operating Humidity	5 to 95% Noncondensing
Certifications	FCC, IC, PTCRB, AT&T

\* Requires 802.3at PoE+ switch.

## Safety Notices

1. Read, follow, and keep these instructions.
2. Heed all warnings.
3. Only use attachments/accessories specified by the manufacturer.



**WARNING:** Do not use this product in location that can be submerged by water.



**WARNING:** Avoid using this product during an electrical storm. There may be a remote risk of electric shock from lightning.

## Electrical Safety Information

1. Compliance is required with respect to voltage, frequency, and current requirements indicated on the manufacturer's label. Connection to a different power source than those specified may result in improper operation, damage to the equipment or pose a fire hazard if the limitations are not followed.
2. There are no operator serviceable parts inside this equipment. Service should be provided only by a qualified service technician.



- a. Do not substitute the power cord with one that is not the provided approved type. Never use an adapter plug to connect to a 2-wire outlet as this will defeat the continuity of the grounding wire.
- b. The equipment requires the use of the ground wire as a part of the safety certification, modification or misuse can provide a shock hazard that can result in serious injury or death.
- c. Contact a qualified electrician or the manufacturer if there are questions about the installation prior to connecting the equipment.
- d. Protective earthing is provided by Listed AC adapter. Building installation shall provide appropriate short-circuit backup protection.
- e. Protective bonding must be installed in accordance with local national wiring rules and regulations.

## Limited Warranty

[ui.com/support/warranty](http://ui.com/support/warranty)

The limited warranty requires the use of arbitration to resolve disputes on an individual basis, and, where applicable, specify arbitration instead of jury trials or class actions.

## Compliance

### FCC

Changes or modifications not expressly approved by the party responsible for compliance could void the user's authority to operate the equipment.

This device complies with Part 15 of the FCC Rules. Operation is subject to the following two conditions.

1. This device may not cause harmful interference, and
2. This device must accept any interference received, including interference that may cause undesired operation.

This equipment has been tested and found to comply with the limits for a Class A digital device, pursuant to part 15 of the FCC Rules. These limits are designed to provide reasonable protection against harmful interference when the equipment is operated in a commercial environment. This equipment generates, uses, and can radiate radio frequency energy and, if not installed and used in accordance with the instruction manual, may cause harmful interference to radio communications. Operations of this equipment in a residential area is likely to cause harmful interference in which case the user will be required to correct the interference at his own expense.

This radio transmitter has been approved by FCC.

### ISED Canada

#### CAN ICES-3(A)/NMB-3(A)

This device complies with ISED Canada licence-exempt RSS standard(s). Operation is subject to the following two conditions:

1. This device may not cause interference, and



This radio transmitter has been approved by ISED Canada.

### CAN ICES-3(A)/NMB-3(A)

Le présent appareil est conforme aux CNR d'ISDE Canada applicables aux appareils radio exempts de licence. L'exploitation est autorisée aux deux conditions suivantes :

1. l'appareil ne doit pas produire de brouillage;
2. l'appareil doit accepter tout brouillage radioélectrique subi, même si le brouillage est susceptible d'en compromettre le fonctionnement.

Le présent émetteur radio a été approuvé par ISDE Canada.

## IMPORTANT NOTE

### Radiation Exposure Statement

- This equipment complies with radiation exposure limits set forth for an uncontrolled environment.
- This equipment should be installed and operated with minimum distance 20 cm between the radiator and your body.
- This transmitter must not be co-located or operating in conjunction with any other antenna or transmitter.

## AVIS IMPORTANT

### Déclaration sur l'exposition aux rayonnements

- Cet équipement est conforme aux limites prévues pour l'exposition aux rayonnements dans un environnement non contrôlé.
- Lors de l'installation et de la mise en fonctionnement de l'équipement, assurez-vous qu'il y ait une distance minimale de 20 cm entre l'élément rayonnant et vous.
- Cet émetteur ne doit être installé à proximité d'aucune autre antenne ni d'aucun autre émetteur, et ne doit être utilisé conjointement à aucun autre de ces appareils.

## Online Resources



